

General Description

The AOZ1331DI is a dual channel load switch with typical 20mΩ on-resistance in a small package. It contains two n-channel MOSFETs for up to 5.5V input voltage operation and 6A current each channel with 2.5V to 5V bias supply. Each load switch is independently controlled by a low voltage control signal through ON1/ON2 pin.

The AOZ1331DI integrates an internal 220Ω load resistor in each channel for quick output discharge when load switch is off. The optional external capacitor connected CT1/CT2 for output slew rate control.

The AOZ1331DI is available in a 3mm x 2mm DFN-14L package with bottom thermal pad and is rated over a -40°C to +85°C ambient temperature range.

Features

- 0.8V to 5.5V input voltage range
- 6A continuous current per channel
- Low $R_{DS(ON)}$ internal NFETs
 - 20mΩ at $V_{BIAS} = 2.5V$ to 5V & $V_{BIAS} \geq V_{IN}$
- Low quiescent current
 - 80μA (both channels)
 - 60μA (single channel)
- Adjustable rise time
- 2.5V to 5V bias voltage
- Integrated quick output discharge resistor
- Thermally enhanced 3mm x 2mm DFN-14L package

Applications

- Portable computers
- Ultrabooks
- Tablet PC
- Set top boxes
- LCD TVs
- Telecom/Networking/Datacom equipment
- SSD
- Consumer electronics



Typical Application

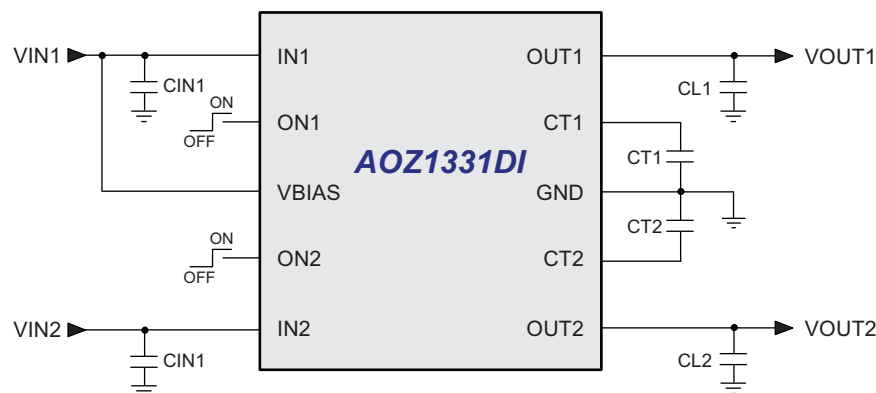

Ordering Information

Part Number	Temperature Range	Package	Environmental
AOZ1331DI	-40°C to +85°C	3mm x 2mm DFN-14L	Green



All AOS products are offered in packages with Pb-free plating and compliant to RoHS standards.

Please visit www.aosmd.com/media/AOSGreenPolicy.pdf for additional information.

Pin Configuration

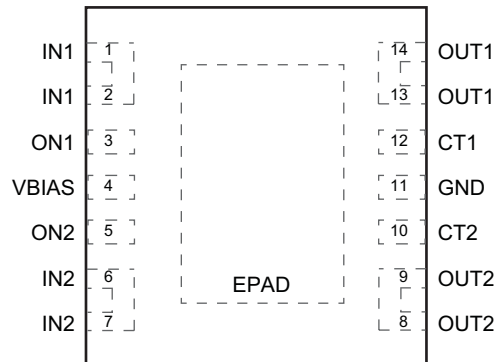

3mm x 2mm DFN-14
(Top View)

Pin Description

Pin Number	Pin Name	Pin Function
1, 2	IN1	Switch 1 Input. Bypass capacitor is recommended to minimize input voltage dip. Recommended voltage range of this pin is 0.8V to V_{BIAS} to obtain optimal R_{ON} .
3	ON1	Enable Input of Switch 1. Switch 1 is on when ON1 is pulled high, and is off when ON1 is pulled low. Do not leave floating.
4	VBIAS	Bias Voltage. Power supply to this device. Recommended voltage range is 2.5V to 5.5V.
5	ON2	Enable Input of Switch 2. Switch 2 is on when ON2 is pulled high, and is off when ON2 is pulled low. Do not leave floating.
6, 7	IN2	Switch 2 Input. Bypass capacitor is recommended to minimize input voltage dip. Recommended voltage range of this pin is 0.8V to V_{BIAS} to obtain optimal R_{ON} .
8, 9	OUT2	Switch 2 Output.
10	CT2	Slew rate control of switch 2.
11	GND	Ground.
12	CT1	Slew rate control of switch 1.
13, 14	OUT1	Switch 1 Output.
EPAD	Exposed Pad	The exposed bottom pad must be connected to GND.

Functional Block Diagram

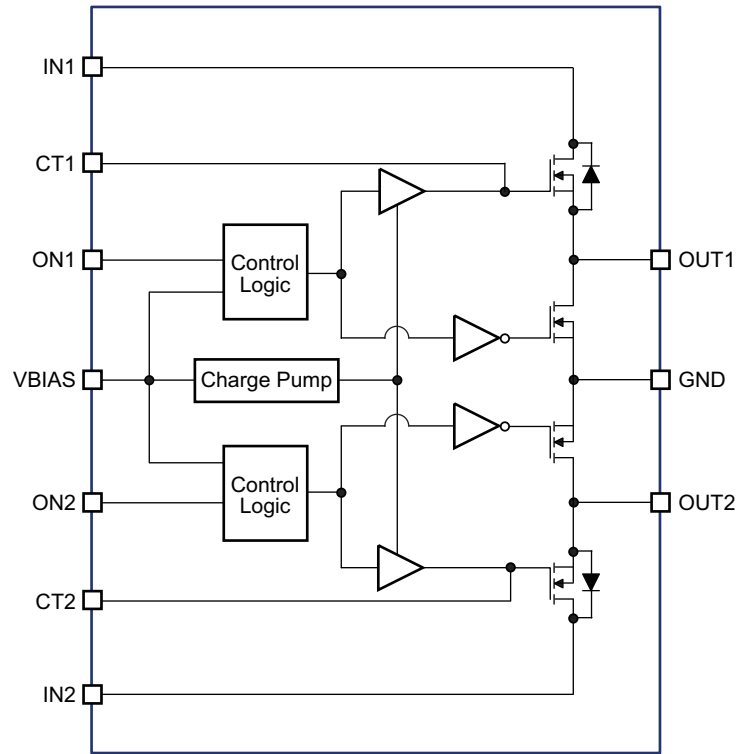

Absolute Maximum Ratings

Exceeding the Absolute Maximum ratings may damage the device.

Parameter	Rating
IN1, IN2, VBIAS, ON1, ON2 to GND	-0.3V to 6V
OUT1, OUT2 to GND	-0.3V to 6V
Junction Temperature (T _J)	+150°C
Storage Temperature (T _S)	-65°C to +150°C
ESD Rating HBM/CDM	2kV/1kV

Recommend Operating Ratings

The device is not guaranteed to operate beyond the Maximum Operating Ratings.

Parameter	Rating
Supply Voltage (V _{IN})	5.5V
Ambient Temperature (T _A)	-40°C to +85°C
Package Thermal Resistance	
3x2 DFN-14 (Θ _{JC})	10°C/W
3x2 DFN-14 (Θ _{JA})	65°C/W

Electrical Characteristics

T_A = 25°C, V_{BIAS} = 5V, unless otherwise specified. Specifications in **BOLD** indicate a temperature range of -40°C to +85°C.

Symbol	Parameter	Conditions	Min.	Typ.	Max.	Units
V _{INX}	IN Supply Voltage		0.8		V _{BIAS}	V
V _{BIAS}	VBIAS Supply Voltage		2.5		5.5	V
I _{D1,2}	Maximum Continuous Current	V _{INX} = V _{ONX} = 5V		6		A
I _{PLS1,2}	Maximum Pulsed Switch Current	V _{INX} = V _{ONX} = 5V Pulse < 300μs, 2% Duty Cycle		8		A
I _{q2}	Quiescent Supply Current of V _{BIAS} (Two Channels)	I _{OUT1} = I _{OUT2} = 0V, V _{IN1,2} = V _{ON1,2} = 5V		80	120	μA
I _{q1}	Quiescent Supply Current of V _{BIAS} (Single Channel)	I _{OUT1} = I _{OUT2} = 0V, V _{IN1,2} = V _{ON1} = 5V, V _{ON2} = 0V		60		μA
I _{OFF}	VBIAS Shutdown Supply Current	V _{ON1,2} = 0V, V _{OUT1,2} = 0V		1	2	μA
I _{INOFF}	IN1, IN2 Shutdown Supply Current (Single Channel)	V _{ONX} = 0V, V _{OUTX} = 0V, V _{INX} = 5V		2.1	8	μA
		V _{ONX} = 0V, V _{OUTX} = 0V, V _{INX} = 3.3V		0.3	3	
		V _{ONX} = 0V, V _{OUTX} = 0V, V _{INX} = 1.8V		0.07	2	
		V _{ONX} = 0V, V _{OUTX} = 0V, V _{INX} = 0.8V		0.04	1	
I _{ON1,2}	ON1, 2 Leakage Current	V _{ON1,2} = 5V			1	μA
V _{ONH1,2}	ON1, 2 High Level Voltage	V _{INX} = 0.8V to 5V	1.2			V
V _{ONL1,2}	ON1, 2 Low Level Voltage	V _{INX} = 0.8V to 5V			0.5	V
Switching ON Resistance						
R _{ON}	Switch ON-State Resistance	I _{OUTX} = -200mA V _{INX} = 0.8V to 5V		20	30	mΩ
R _{PD}	Output Pull-Down Resistance	I _{OUTX} = 15mA V _{INX} = 5V, V _{ONX} = 0V		220	300	Ω

Note:

Greater on-resistance if V_{IN} > V_{BIAS}.

Switching Characteristics

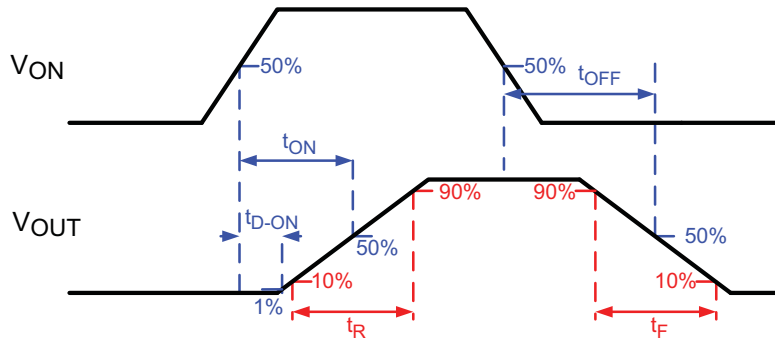

Test conditions: T_A = 25°C, C_{INX} = 1μF, C_{TX} = 1nF, C_{LX} = 0.1μF, R_{LX} = 10Ω (unless otherwise specified).

Symbol	Parameter	Min.	Typ.	Max.	Units
VINX = 5V, VBIAS = VONX = 5V					
t _{ON}	Turn-ON Time		1475		μs
t _{D-ON}	Turn-ON Delay time		370		
t _R	Turn-ON Rise Time		1875		
t _{OFF}	Turn-OFF Time		5.8		
t _F	Turn-OFF Fall Time		2.8		
VINX = 0.8V, VBIAS = VONX = 5V					
t _{ON}	Turn-ON Time		560		μs
t _{D-ON}	Turn-ON Delay time		350		
t _R	Turn-ON Rise Time		338		
t _{OFF}	Turn-OFF Time		158		
t _F	Turn-OFF Fall Time		20		
VINX = 2.5V, VBIAS = VONX = 2.5V					
t _{ON}	Turn-ON Time		2050		μs
t _{D-ON}	Turn-ON Delay time		700		
t _R	Turn-ON Rise Time		2150		
t _{OFF}	Turn-OFF Time		6.5		
t _F	Turn-OFF Fall Time		2		
VINX = 0.8V, VBIAS = VONX = 2.5V					
t _{ON}	Turn-ON Time		1230		μs
t _{D-ON}	Turn-ON Delay time		650		
t _R	Turn-ON Rise Time		730		
t _{OFF}	Turn-OFF Time		135		
t _F	Turn-OFF Fall Time		16		

Typical Characteristics

Quiescent Current vs. VBIAS (Single Channel)
(VIN=VBIAS, VON1=5V, VON2=0V)

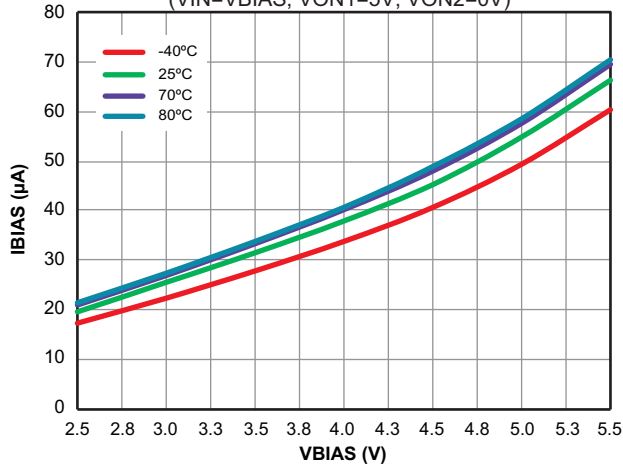

RSDON vs. VIN
(VBIAS=5.5V, IOU=-200mA)

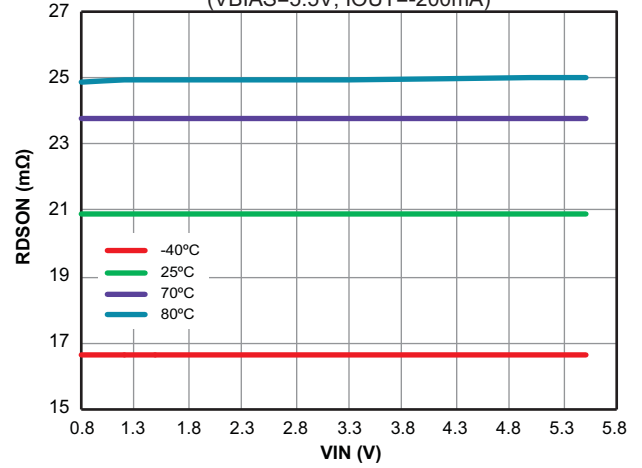

Quiescent Current vs. VBIAS (Both Channels)
(VIN=VBIAS, VON1=5V, VON2=5V)

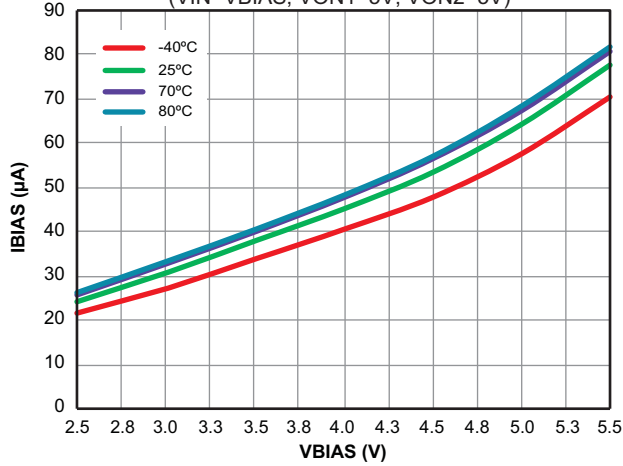

RPD vs. VIN
(VBIAS=5.5V)

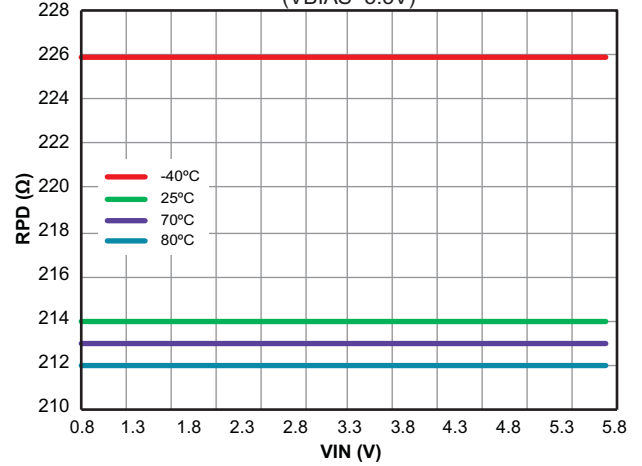

RDSON vs. VIN
(VBIAS=2.5V, IOU=-200mA)

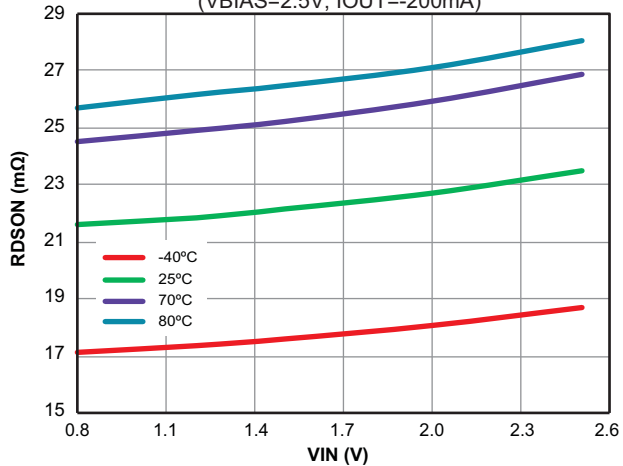

VOUT vs. VON
(TA=25°C, VIN=2V)

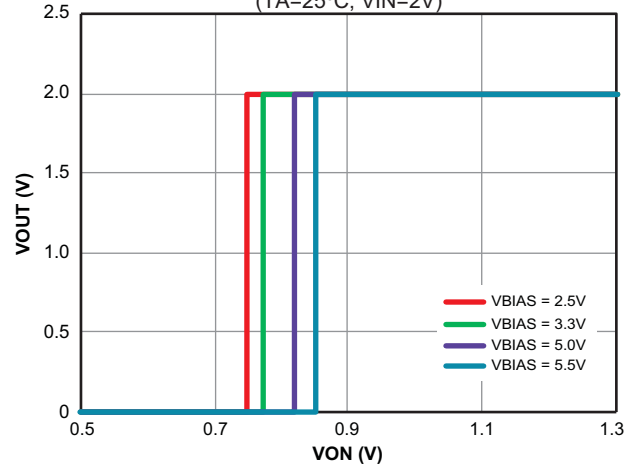

Typical Characteristics (Continued)

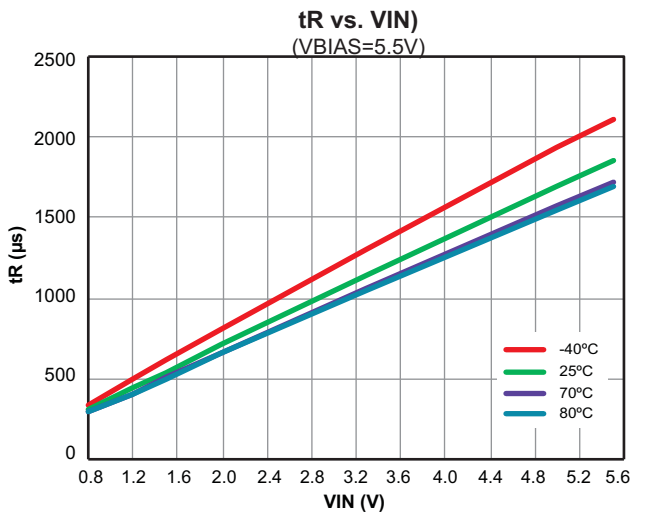
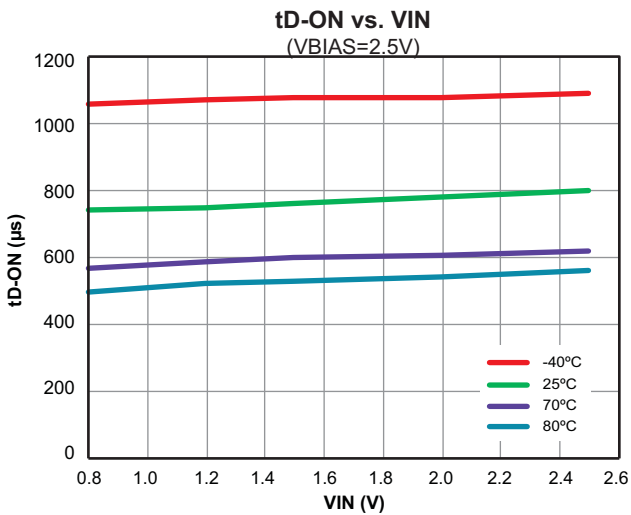
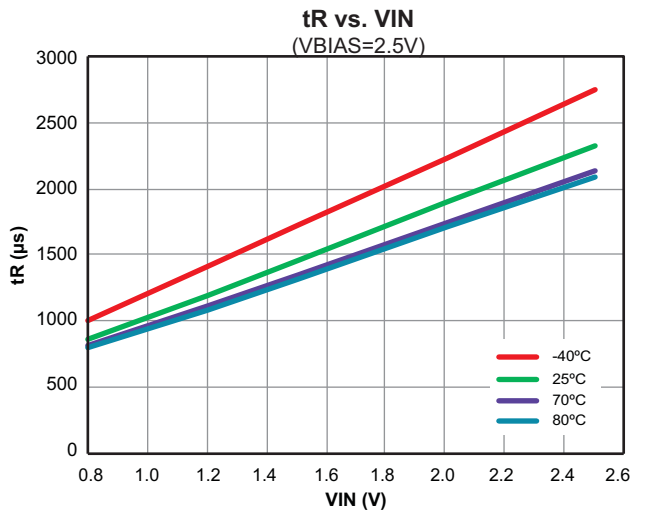
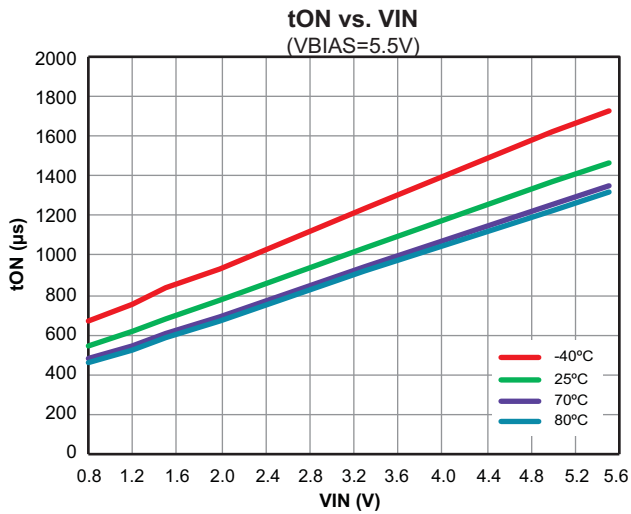
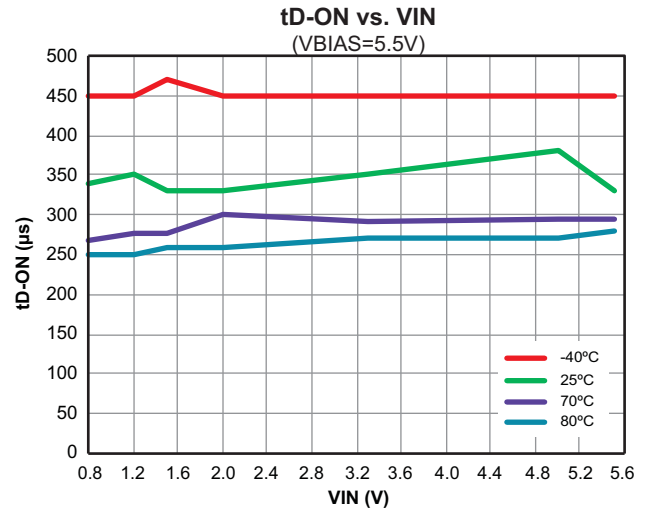
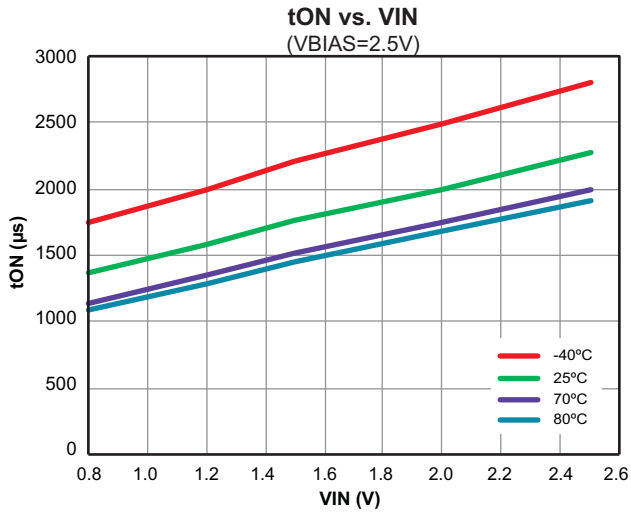

Typical Characteristics (Continued)

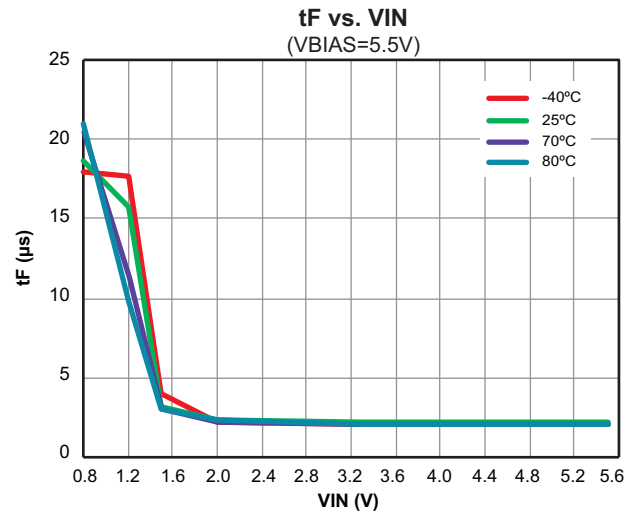
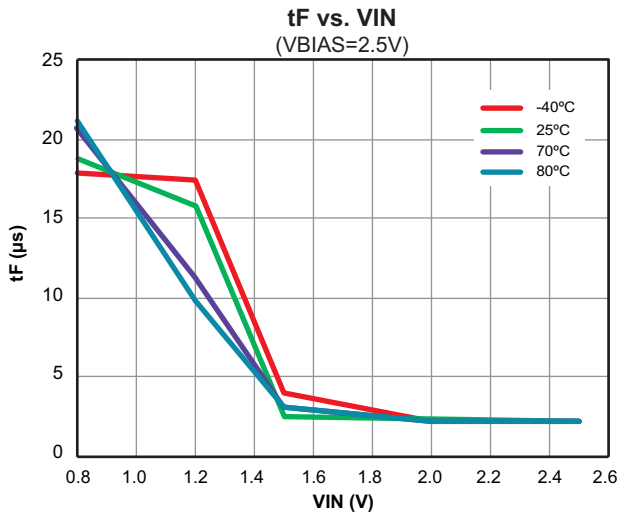
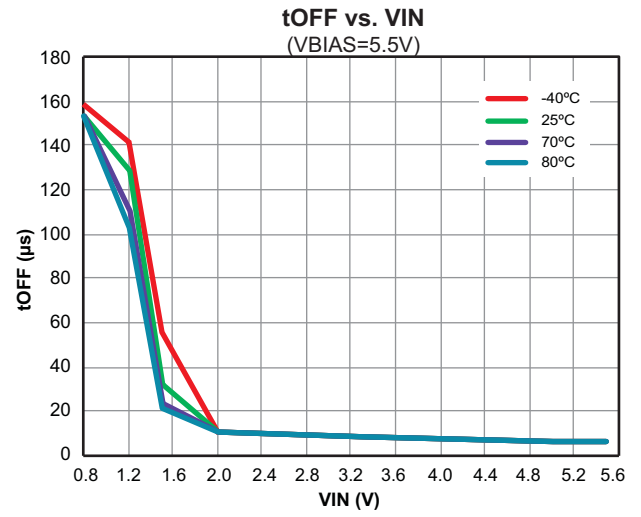
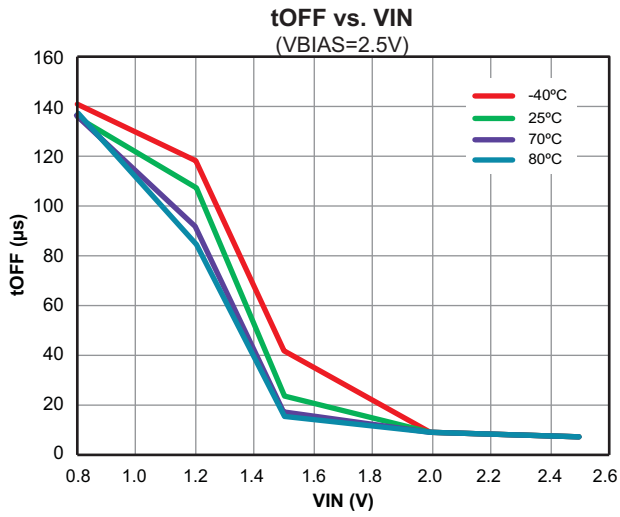

Functional Characteristics

Turn-ON & Turn-ON Rise Times

($V_{INX}=5V$, $V_{BIAS}=5V$, $C_{INX}=1\mu F$, $C_{TX}=1nF$, $C_{LX}=0.1\mu F$, $R_{LX}=10\Omega$)

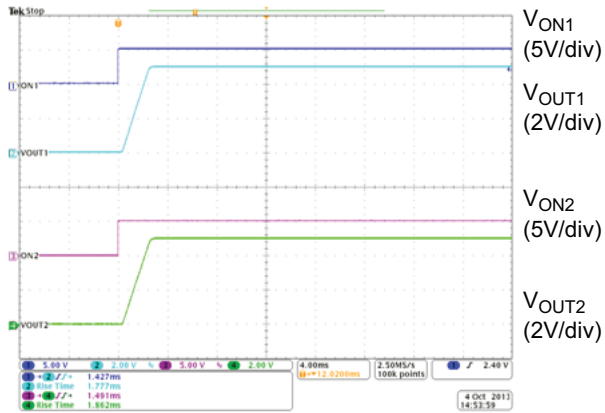

Turn-ON & Turn-ON Rise Times

($V_{INX}=0.8V$, $V_{BIAS}=5V$, $C_{INX}=1\mu F$, $C_{TX}=1nF$, $C_{LX}=0.1\mu F$, $R_{LX}=10\Omega$)

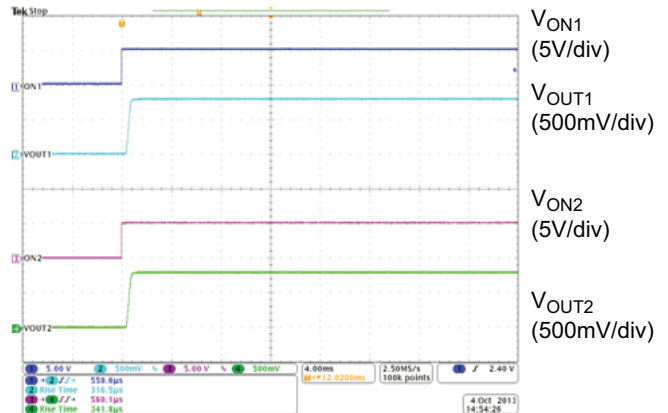

Turn-ON & Turn-ON Rise Times

($V_{INX}=2.5V$, $V_{BIAS}=2.5V$, $C_{INX}=1\mu F$, $C_{TX}=1nF$, $C_{LX}=0.1\mu F$, $R_{LX}=10\Omega$)

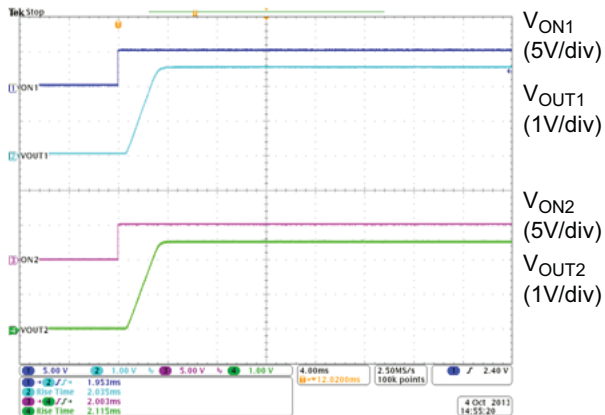

Turn-ON & Turn-ON Rise Times

($V_{INX}=0.8V$, $V_{BIAS}=2.5V$, $C_{INX}=1\mu F$, $C_{TX}=1nF$, $C_{LX}=0.1\mu F$, $R_{LX}=10\Omega$)

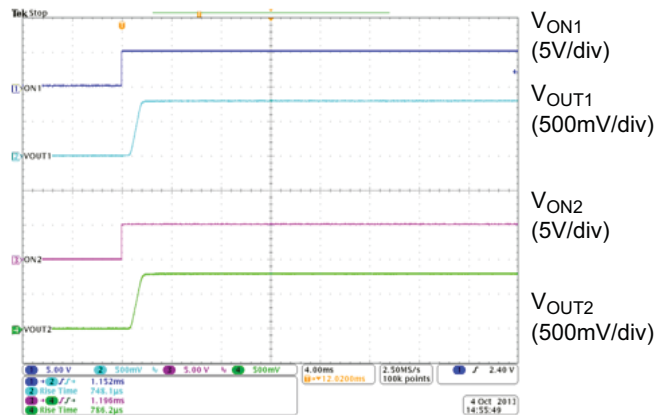

Turn-OFF & Turn-OFF Fall Times

($V_{INX}=5V$, $V_{BIAS}=5V$, $C_{INX}=1\mu F$, $C_{TX}=1nF$, $C_{LX}=0.1\mu F$, $R_{LX}=10\Omega$)

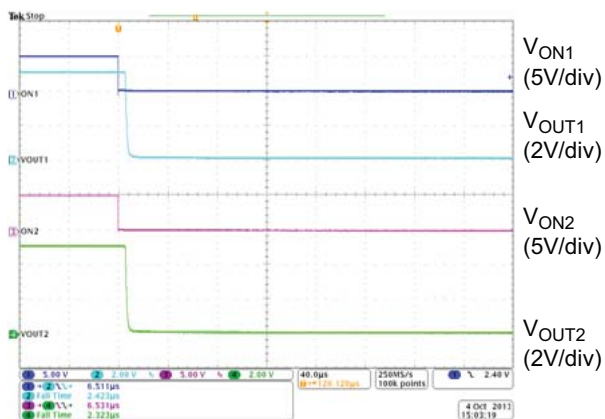

Turn-OFF & Turn-OFF Fall Times

($V_{INX}=0.8V$, $V_{BIAS}=5V$, $C_{INX}=1\mu F$, $C_{TX}=1nF$, $C_{LX}=0.1\mu F$, $R_{LX}=10\Omega$)

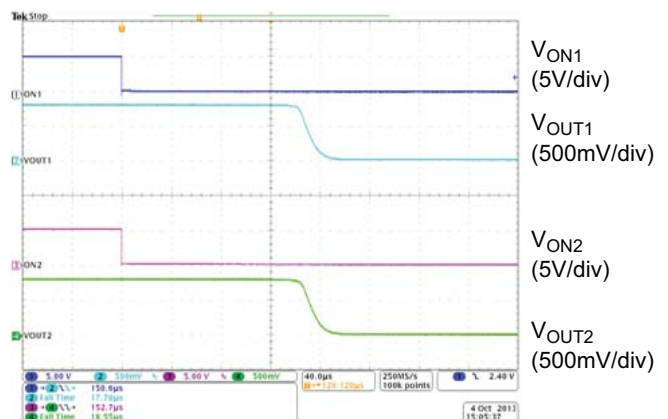

Functional Characteristics (Continued)

Turn-OFF & Turn-OFF Fall Times

($V_{INX}=2.5V$, $V_{BIAS}=2.5V$, $C_{INX}=1\mu F$, $C_{TX}=1nF$, $C_{LX}=0.1\mu F$, $R_{LX}=10\Omega$)

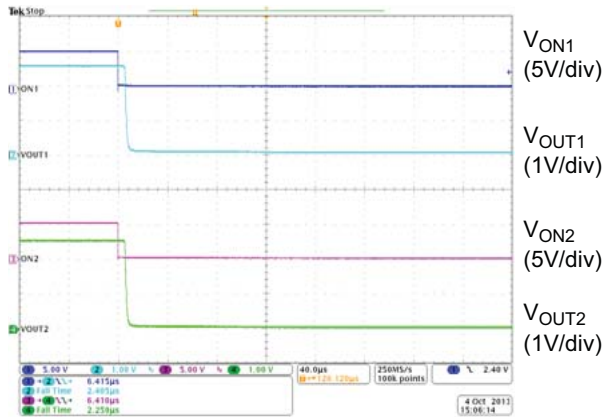

Turn-OFF & Turn-OFF Fall Times

($V_{INX}=0.8V$, $V_{BIAS}=2.5V$, $C_{INX}=1\mu F$, $C_{TX}=1nF$, $C_{LX}=0.1\mu F$, $R_{LX}=10\Omega$)

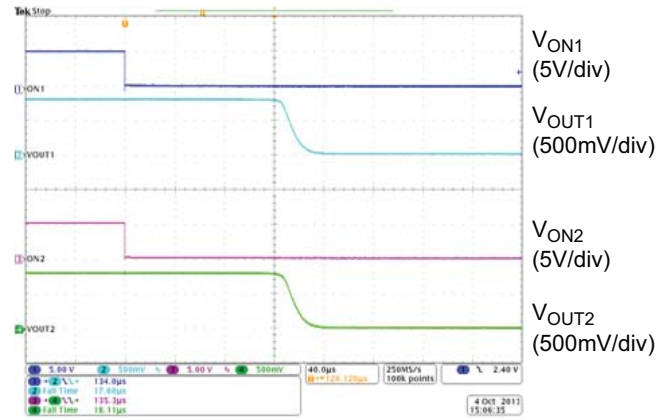

Turn-ON & Turn-OFF @ I_{OUT} = 6A

($V_{IN1}=5V$, $V_{BIAS}=5V$, $C_{IN1}=4.7\mu F$, $C_{L1}=4.7\mu F$)

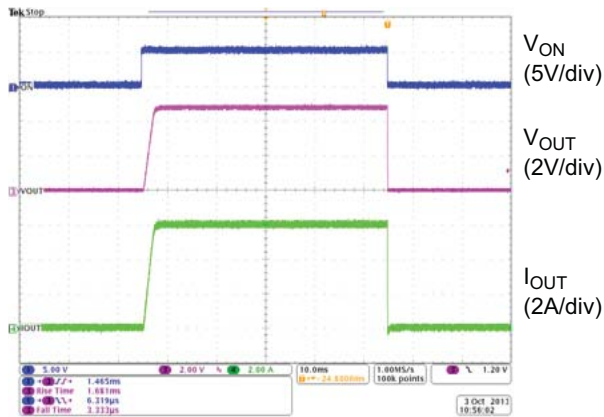

Turn-ON & Turn-OFF @ I_{OUT} = 6A

($V_{IN1}=2.5V$, $V_{BIAS}=5V$, $C_{IN1}=4.7\mu F$, $C_{L1}=4.7\mu F$)

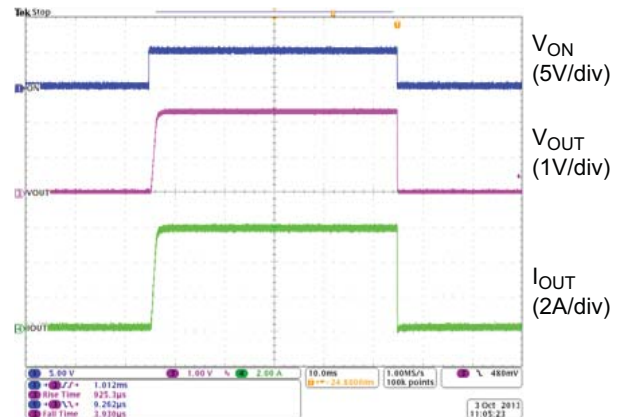

Detailed Description

ON/OFF Control

The AOZ1331DI is enabled when the ON pin is on active high with 1.2V or above voltage. The device is disabled when the ON pin voltage is 0.5V or lower. The EN input is compatible with both TTL and CMOS logic.

VBIAS Voltage Range

For optimal on-resistance of load switch, make sure $V_{IN} \leq V_{BIAS}$ and V_{BIAS} is within the voltage range from 2.5V to 5.5V. On-resistance of load switch will be higher if $V_{IN} > V_{BIAS}$. Resistance curves of a typical sample device at different V_{BIAS} and different V_{IN} are shown as below.

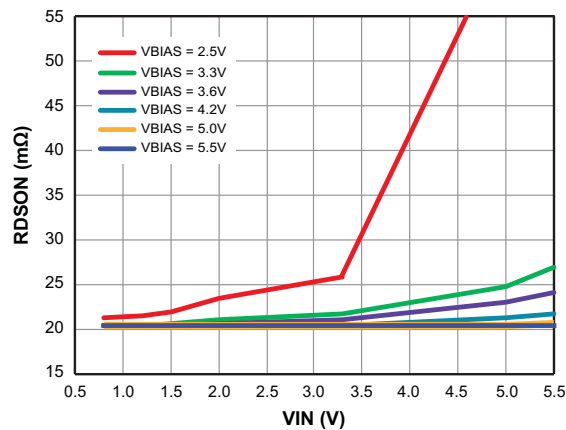

Adjustable Rise Time

The slew rate of each channel can be adjusted individually by external capacitors connected to the corresponding CT and GND pins. Multiply the input voltage and the slew rate to obtain the rise time. The table below shows rise times, which are measured on a typical device at $V_{BIAS} = 5V$.

C _{TX} (pF)	Rise Time (μs) 10%~90%, C _{LX} =0.1μF, C _{INX} =1μF, R _{LX} =10Ω (Typical values at 25°C, 25V X7R 10% Ceramic Cap)						
	V _{INX} =5V	3.3V	1.8V	1.5V	1.2V	1.05V	0.8V
0	85	68	49	45	40	37	34
220	431	297	172	147	122	106	89
470	888	583	332	269	218	189	161
1000	1700	1130	657	550	446	390	316
2200	3805	2534	1347	1152	966	867	701
4700	8053	5255	1997	2578	2101	1838	1483
10000	18330	12050	5545	5545	4155	4155	3329

Applications Information

The basic AOZ1331DI application circuit is shown in the first page. Component selection is explained below.

Input Capacitor Selection

A capacitor of 1μF or higher value is recommended to be placed close to the IN pins of AOZ1331DI. This capacitor can reduce the voltage drop caused by the in-rush current during the turn-on transient of the load switch. A higher value capacitor can be used to further reduce the voltage drop during high-current application.

Output Capacitor Selection

A capacitor of 0.1μF or higher value is recommended to be placed between the OUT pins and GND. The switching times are affected by the capacitance. A larger capacitor makes the initial turn-on transient smoother. This capacitor must be large enough to supply a fast transient load in order to prevent the output from dropping.

Thermal Considerations

To ensure proper operation, the maximum junction temperature of the AOZ1331DI should not exceed 150°C. Several factors attribute to the junction temperature rise: load current, MOSFET on-resistance, junction-to-ambient thermal resistance, and ambient temperature. The maximum load current can be determined by:

$$I_{LOAD(MAX)} = \sqrt{\frac{T_{J(MAX)} - T_C}{\Theta_{JC} \times R_{DS(on)}}$$

It is noted that the maximum continuous load current is 6A.

Layout Guidelines

Good PCB is important for improving the thermal performance of AOZ1331DI. Place the input and output bypass capacitors close to the IN and OUT pins. The input and output PCB traces should be as wide as possible for the given PCB space. Use a ground plane to enhance the power dissipation capability of the device.

Package Dimensions, DFN3x2A_14L, EP1_S

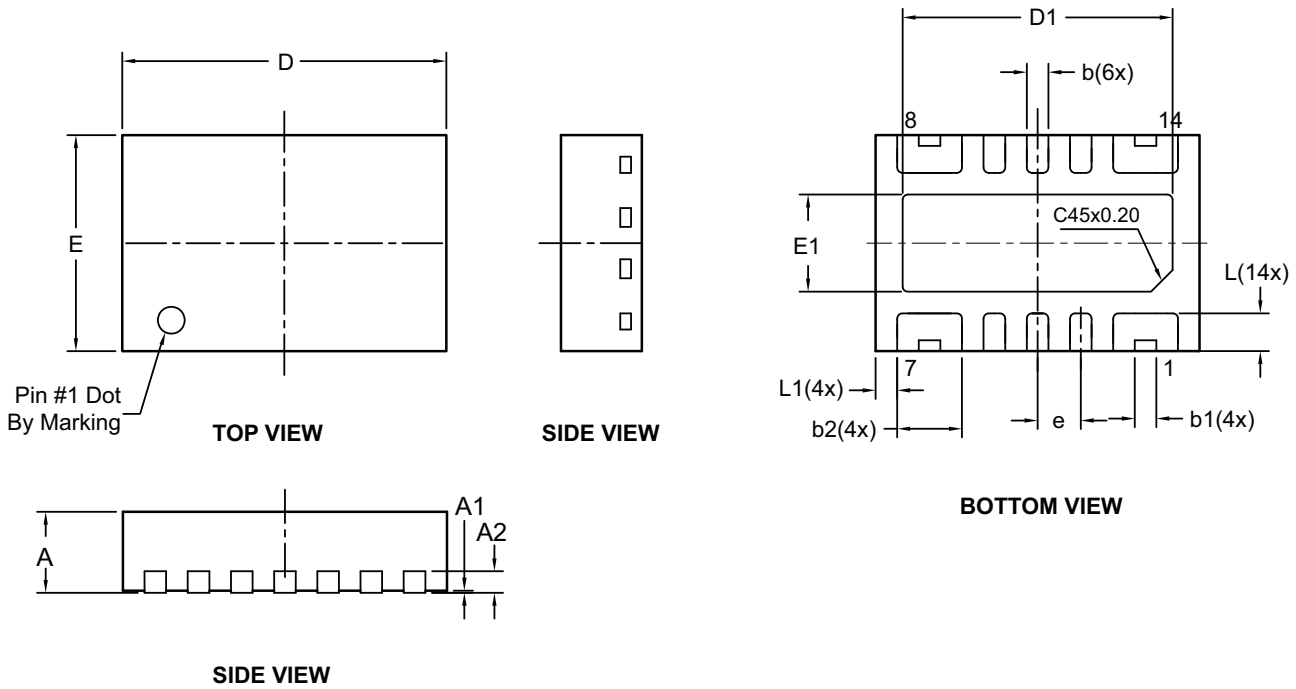

RECOMMENDED LAND PATTERN

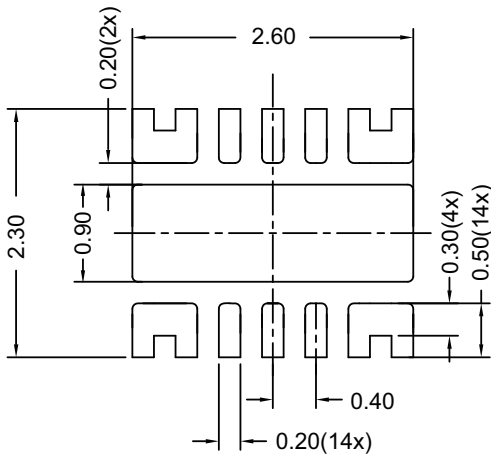

Unit: mm

Dimensions in millimeters

Symbols	Min.	Typ.	Max.
A	0.70	0.75	0.80
A1	0.00	---	0.05
A2	0.2 REF		
E	1.90	2.00	2.10
E1	0.80	0.90	1.00
D	2.90	3.00	3.10
D1	2.40	2.50	2.60
L	0.30	0.35	0.40
L1	0.15	0.20	0.25
b	0.15	0.20	0.25
b1	0.15	0.20	0.25
b2	0.55	0.60	0.65
e	0.40 BSC		

Dimensions in inches

Symbols	Min.	Typ.	Max.
A	0.028	0.030	0.031
A1	0.000	---	0.002
A2	0.008 REF		
E	0.075	0.079	0.083
E1	0.031	0.035	0.039
D	0.114	0.118	0.122
D1	0.094	0.098	0.102
L	0.012	0.014	0.016
L1	0.006	0.008	0.010
b	0.006	0.008	0.010
b1	0.006	0.008	0.010
b2	0.022	0.024	0.026
e	0.016 BSC		

Notes:

1. Controlling dimensions are in millimeters. Converted inch dimensions are not necessarily exact.
2. Tolerance is ± 0.05 , unless otherwise specified.
3. Radius on all corners is 0.152 (max), unless otherwise specified.
4. Package wrapage is 0.012 (max).
5. No plastic flash allowed on the top or bottom lead surface.
6. Pad planarity is ± 0.102 .
7. Crack between plastic body and lead is not allowed.

Tape and Reel Dimensions, DFN3x2A_14L, EP1_S

Carrier Tape

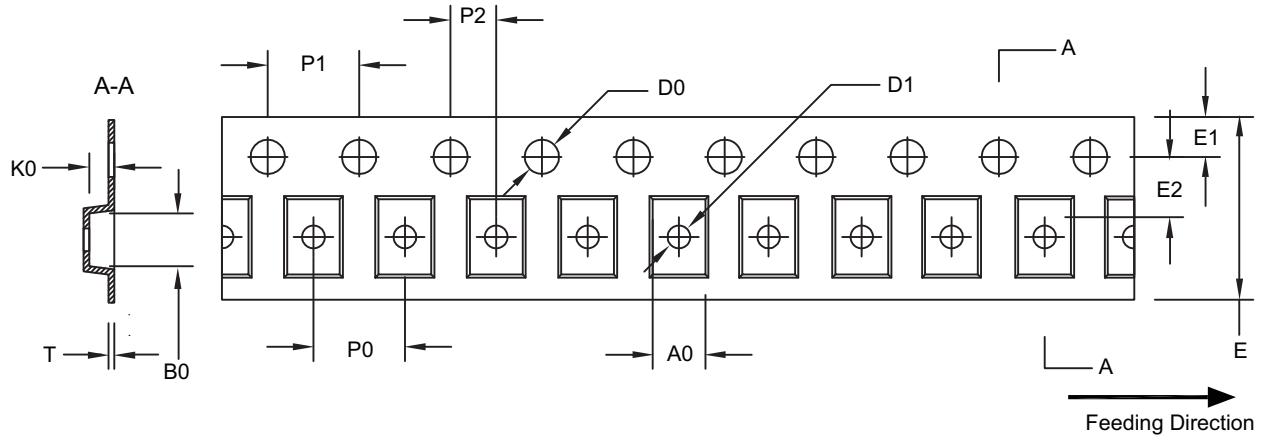

UNIT: MM

Package	A0	B0	K0	D0	D1	E	E1	E2	P0	P1	P2	T
PIC DFN3x2	2.20 ±0.10	3.20 ±0.10	1.03 ±0.10	1.50 +0.10 -0.0	1.00 +0.25 -0.0	8.00 +0.30 -0.1	1.75 ±0.10	3.50 ±0.05	4.00 ±0.10	4.00 ±0.10	2.00 ±0.05	0.23 ±0.02

Reel

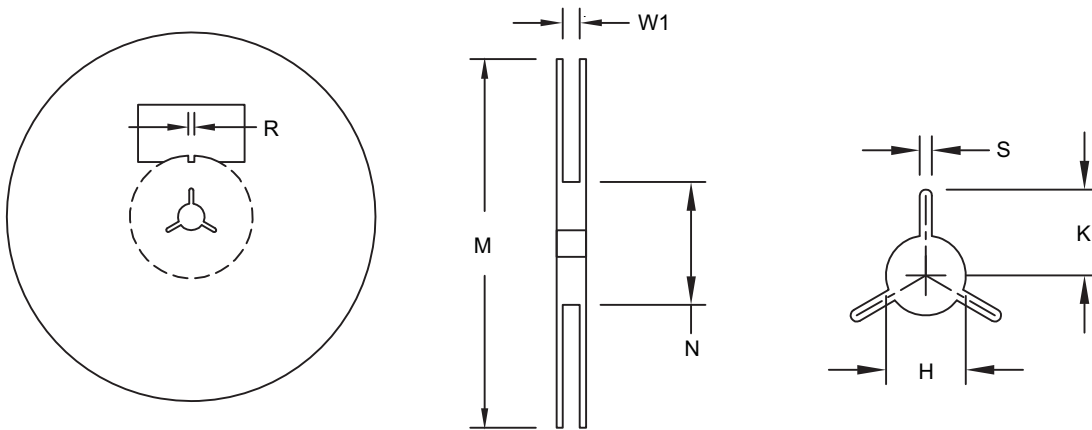

UNIT: MM

Tape Size	Reel Size	M	N	W1	H	S	K	R
8mm	Ø180	Ø180.00 ±0.50	60.00 ±0.50	8.40 +1.50 -0.0	13.00 ±0.20	1.50 MIN.	13.50 MIN.	3.00 ±0.50

Leader/Trailer and Orientation

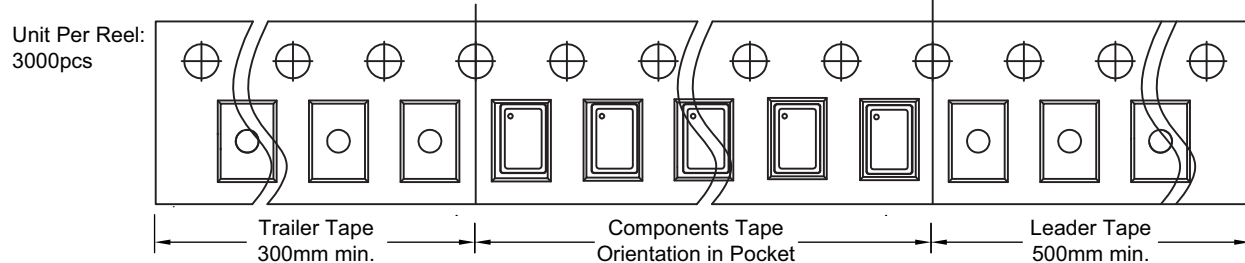

Package Marking

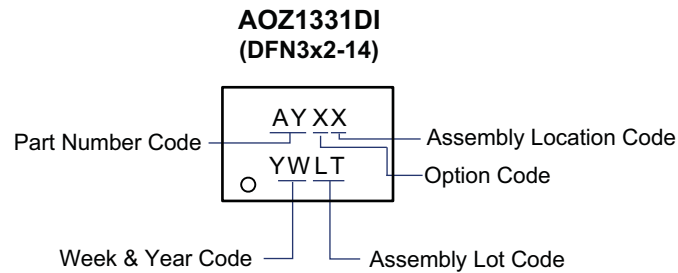

LEGAL DISCLAIMER

Applications or uses as critical components in life support devices or systems are not authorized. AOS does not assume any liability arising out of such applications or uses of its products. AOS reserves the right to make changes to product specifications without notice. It is the responsibility of the customer to evaluate suitability of the product for their intended application. Customer shall comply with applicable legal requirements, including all applicable export control rules, regulations and limitations.

AOS' products are provided subject to AOS' terms and conditions of sale which are set forth at:
http://www.aosmd.com/terms_and_conditions_of_sale

LIFE SUPPORT POLICY

ALPHA AND OMEGA SEMICONDUCTOR PRODUCTS ARE NOT AUTHORIZED FOR USE AS CRITICAL COMPONENTS IN LIFE SUPPORT DEVICES OR SYSTEMS.

As used herein:

- | | |
|---|---|
| <p>1. Life support devices or systems are devices or systems which, (a) are intended for surgical implant into the body or (b) support or sustain life, and (c) whose failure to perform when properly used in accordance with instructions for use provided in the labeling, can be reasonably expected to result in a significant injury of the user.</p> | <p>2. A critical component in any component of a life support, device, or system whose failure to perform can be reasonably expected to cause the failure of the life support device or system, or to affect its safety or effectiveness.</p> |
|---|---|